

Bluetooth USB Adapter

Parani-UD100

User Guide

Version 1.0.2

2011-05-16

User Guide for the Parani-UD100

Document Version 1.0.2

Firmware version 1.0.X

Printed in Korea

Copyright

Copyright 2011, Sena Technologies, Inc. All rights reserved.

Sena Technologies reserves the right to make changes and improvements to its product without providing notice.

Trademark

Parani™ is a trademark of Sena Technologies, Inc.

Windows® is a registered trademark of Microsoft Corporation.

Ethernet® is a registered trademark of XEROX Corporation.

Notice to Users

When a system failure may cause serious consequences, protecting life and property against such consequences with a backup system or safety device is essential. The user agrees that protection against consequences resulting from system failure is the user's responsibility.

This device is not approved for life-support or medical systems.

Changes or modifications to this device not explicitly approved by Sena Technologies will void the user's authority to operate this device.

Precautions and Safety

Do not drop or subject the device to impact. Damage to your products may result from improper use.

Keep away from harsh environments including humid, dusty, and smoky areas. Damage to your products may result from improper use.

Do not use excessive force on the buttons or attempt to disassemble the device. Damage to your products may result from improper use.

Do not place heavy objects on the product. Damage to your products may result from improper use.

Revision History

Revision	Date	Name	Description
V1.0.0	2009-01-29	CP Moon	Initial Revision History
V1.0.1	2009-06-01	CP Moon	Update product specification Add using Bluetooth stereo headset
V1.0.2	2011-05-16	WJ Kim	Add note

Contents

1. Introduction	5
1.1. Overview.....	5
1.2. Package Check List	5
1.3. Product Specification.....	6
2. Installing the Bluetooth Software	7
3. Using the Bluetooth Adapter	10
3.1. Using Bluetooth Serial Port	11
3.2. Using Dial-up Network (DUN).....	16
3.3. Using Bluetooth Stereo Headset	20
Appendix A. Mechanical Drawing	24
Appendix B. Warranty	25
B.1. GENERAL WARRANTY POLICY	25
B.2. LIMITATION OF LIABILITY	25
B.3. HARDWARE PRODUCT WARRANTY DETAILS	25
B.4. SOFTWARE PRODUCT WARRANTY DETAILS	26
B.5. THIRD-PARTY SOFTWARE PRODUCT WARRANTY DETAILS	26
Appendix C. Contact Information	27

1. Introduction

1.1. Overview

Thank you for purchasing Parani-UD100. Parani-UD100 is a Bluetooth-USB adapter with replaceable external antenna. Parani-UD100 supports Bluetooth 2.0+EDR class 1 with working distance up to 300 meters. In addition, working distance can be further extended using optional dipole or patch antennas. Parani-UD100 supports USB 2.0 for the computer interface and can be used with Windows using Bluetooth stack driver included in the CD or MAC OS X using MAC OS X Bluetooth stack driver.

1.2. Package Check List

- Parani-UD100
- Stub Antenna
- Quick Start Guide
- CD-ROM including Windows Bluetooth driver, User Guide and Data sheet

1.3. Product Specification

Standards	Bluetooth 2.0+EDR Class 1 USB 2.0
Max Transfer Rate	3 Mbps (EDR)
Frequency Range	2.402 ~ 2.480GHz
Transmit Output Power	+19dBm (+6dBm EDR) E.I.R.P
Receive Sensitivity	Basic 1Mbps: -88 dBm EDR 2Mbps: -87dBm EDR 3Mbps: -82dBm
Antenna Connector	RP-SMA
Antenna Gain	Default Stub Antenna: 1 dBi Optional Dipole Antennas: 3 dBi & 5 dBi Optional Patch Antenna: 9 dBi
Working Distance (In Open Field)	Stub antenna – Stub antenna: 300 m Dipole (3 dBi) – Dipole (3 dBi) : 400 m Dipole (5 dBi) – Dipole (5 dBi): 600 m Patch antenna – Patch antenna: 1 km * working distance can vary depending on install environment
Bluetooth Stack Software	Toshiba
Bluetooth Profiles	DUN, FAX, LAP, SPP, HID, HCRP, FTP, OPP, A2DP, AVRCP, GAVDP, HSP, HFP, PAN, BIP
Computer OS Support	Windows 2000/XP/Vista (32/64bit) Linux (3rd party driver required) MAC OS X (MAC OS X driver required)
Size	72(L) x 22(W) x 10(H) mm
Operating Temperature	-20 ~ +70°C
Storage Temperature	-40 ~ +85°C
Humidity	90% Non-condensing
Regulatory Approvals	FCC, CE, TELEC, KCC, Bluetooth SIG
Warranty	1 year limited warranty



Note *:

[Bluetooth v2.0 supports improved AFH function. AFH function is to mitigate the interference between WiFi and Bluetooth radios by automatically avoiding the active WiFi channel from Bluetooth link. However, AFH does not provide a complete solution making WiFi and Bluetooth work together in harmony. It is highly recommended for users to test their wireless system enough before deployment since the overall system performance is affected by various environmental factors such as distance between them.](#)

2. Installing the Bluetooth Software

This chapter describes how to install and set up the Bluetooth software on your computer when you plug the Parani-UD100 to your computer for the first time.

Before connecting the Parani-UD100, you must install the Bluetooth software. You should also uninstall any kind of Bluetooth driver or utility already installed on your computer such as Widcomm BTW or Toshiba, if any.

- a. Insert the installation software CD.
- b. Click on “Install Bluetooth Utility / Driver”
- c. The InstallShield wizard is started. Click the Next button. (Figure 2.1)
- d. Read the License and click the “I accept the terms in the license agreement” radio button. Then click the Next button. (Figure 2.2)

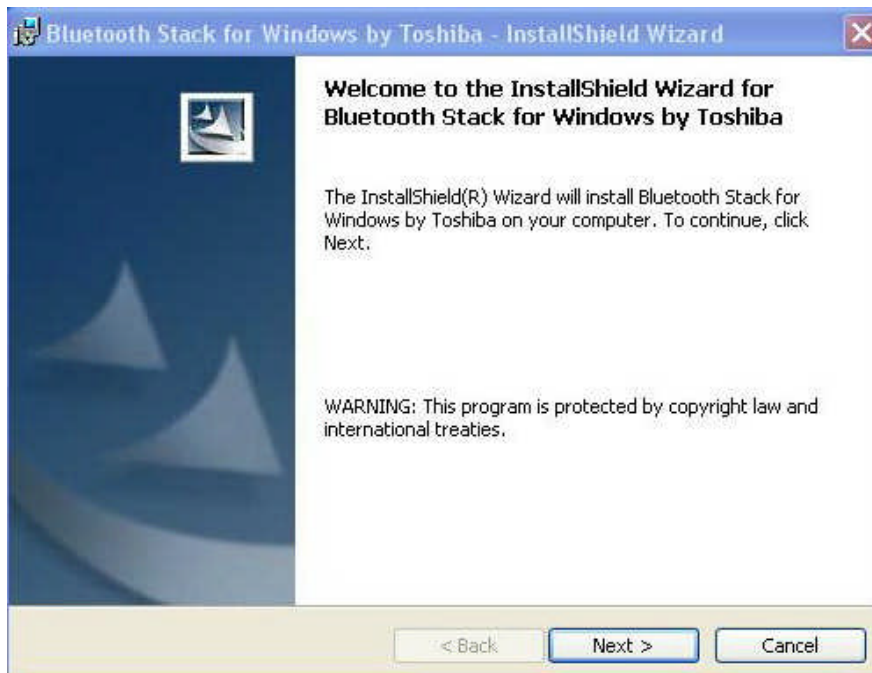

Figure 2.1: InstallShield wizard



Figure 2.2: License Agreement

- e. Click the Install button to begin the installation. (Figure 2.3)
- f. During installation, you should plug in the Parani-UD100 to USB port. After plugging in it, click the OK button. (Figure 2.4)

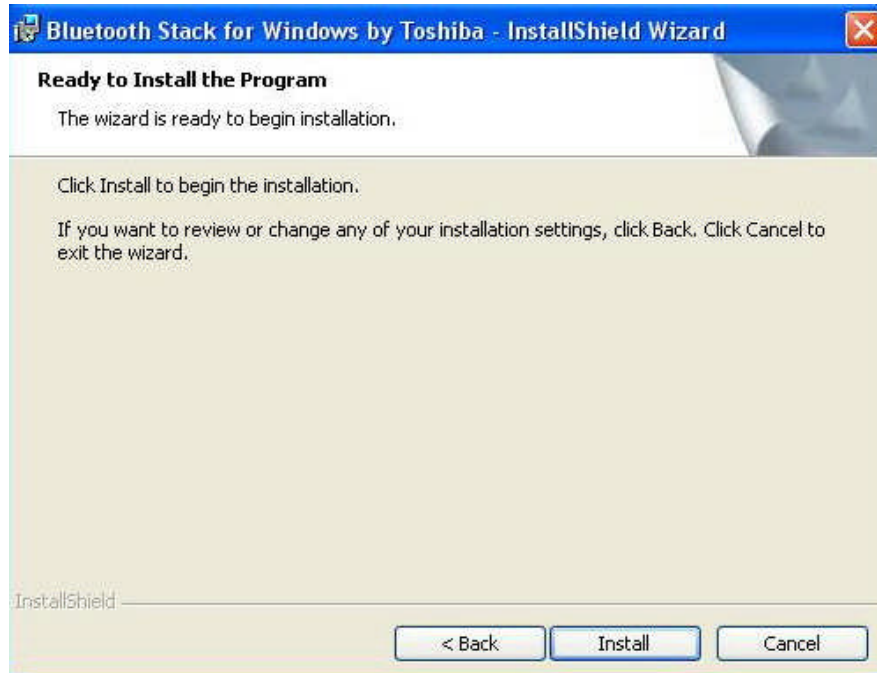

Figure 2.3: Ready to install

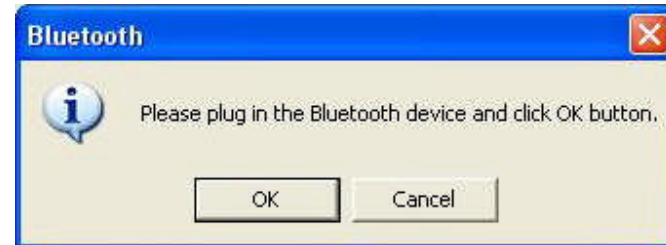

Figure 2.4: Plug in the Bluetooth device

- g. Installation is completed. Click the Finish button.
- h. Click the Yes button to restart your PC.

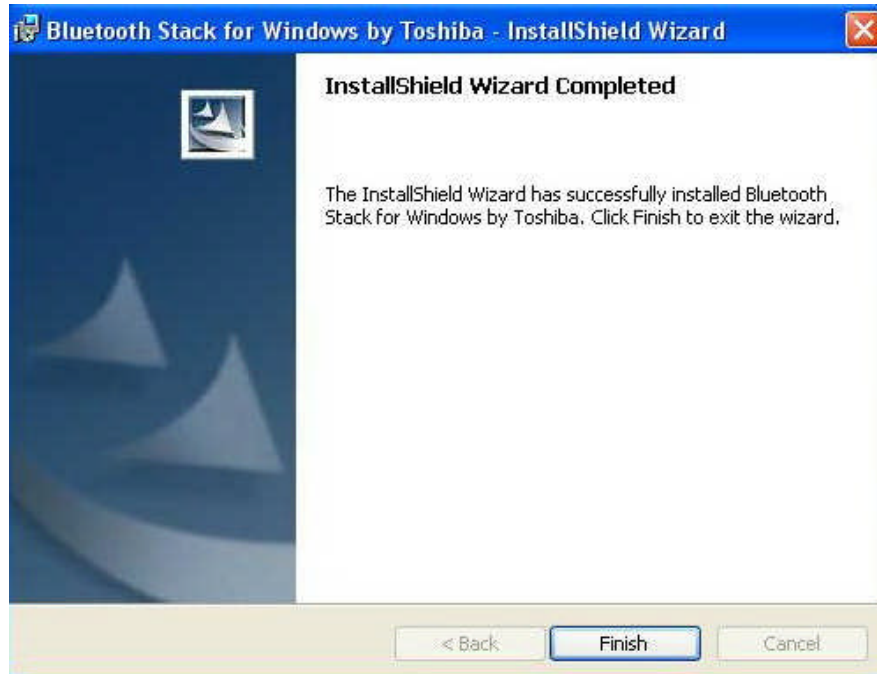

Figure 2.5: InstallShield wizard complete



Figure 2.6: restart your PC



Note: Latest Toshiba Device Driver

<http://aps2.toshiba-tro.de/bluetooth/index.php?page=download-toshiba>

3. Using the Bluetooth Adapter

This chapter describes how you can use Parani-UD100 to make use of SPP and DUN services. For more information on other Bluetooth services, please refer to the online Help provided by the Bluetooth Manager software. To open the Bluetooth Manager Help, please right-click on the Bluetooth Manager icon on the tray, and then click on “Help” (Figure 3.1).

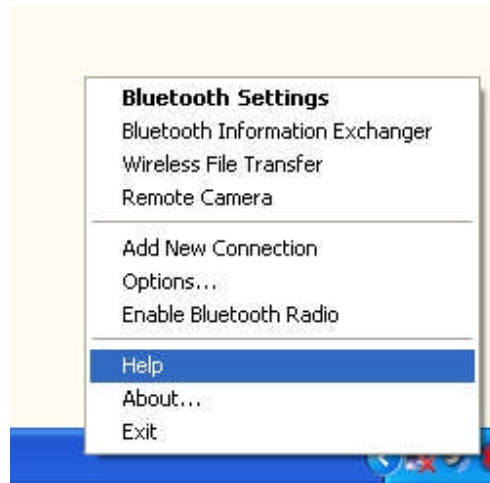

Figure 3.1: Getting Help File

3.1. Using Bluetooth Serial Port

This section describes how to use the Bluetooth serial port.

The Bluetooth Serial Port (SPP) provides a virtual serial port via Bluetooth. Any program that uses a standard serial port can use the Bluetooth serial port. A Bluetooth passkey (PIN code) is required for to connect to. Please confirm your Bluetooth PIN code.

- a. Right-click on the Bluetooth Manager icon in the tray, and then click on “Add New Connection” (Figure 3-2)
- b. Select the “Custom Mode”, and then click the “Next” button (Figure 3-3)

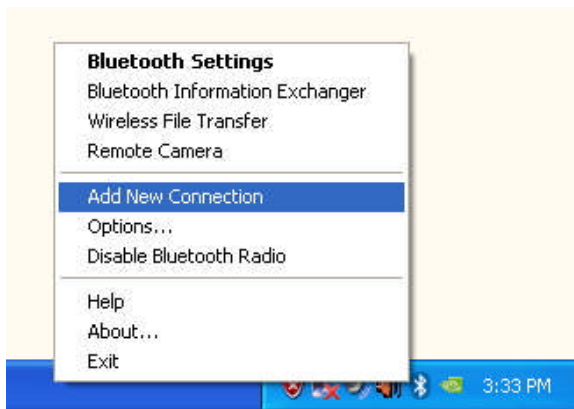

Figure 3.2: Add New Connection



Figure 3.3: Select the “Custom Mode”

- c. Select the device name, and then click the “Next” button. (Figure 3.4)
- d. Select "Serial Port", and then click the “Next” button (Figure 3.5)



Figure 3.4: Select the Device

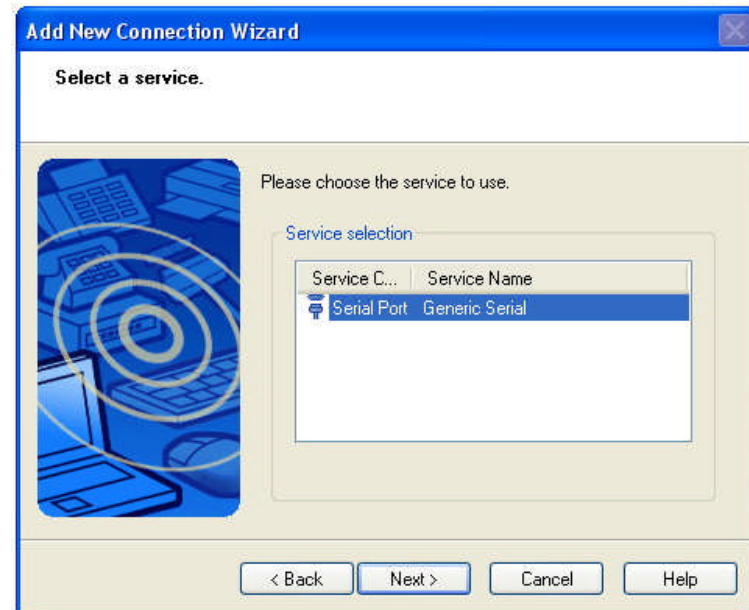

Figure 3.5: Select “Serial Port”

- e. Select a COM port to use, and click the “Next” button. (Figure 3.6)
- f. Click the “Next” button (Figure 3.7)

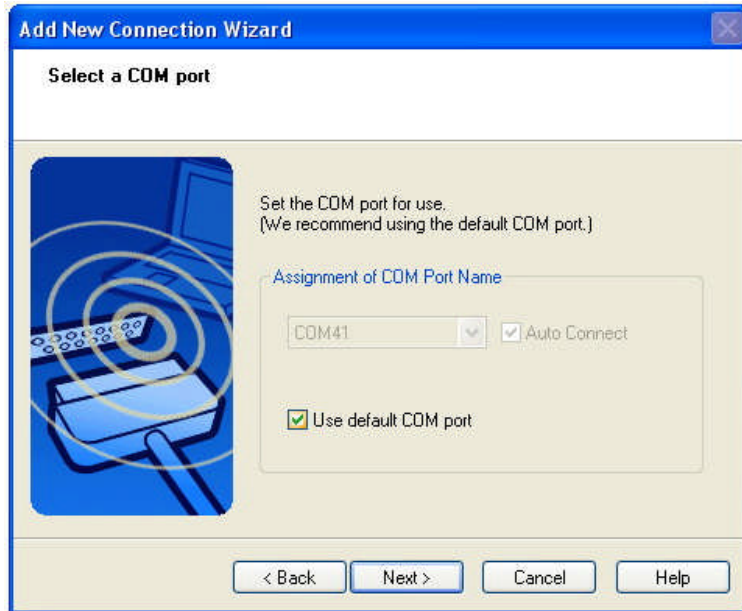

Figure 3.6: Select a COM port

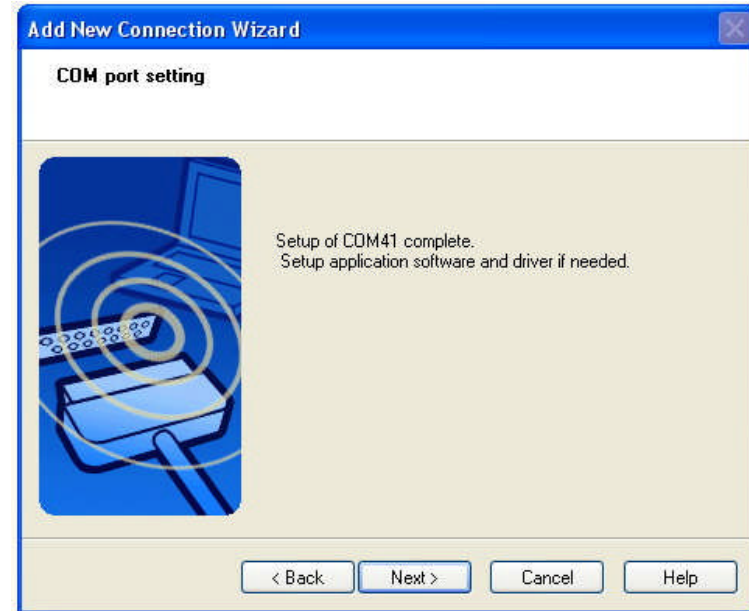

Figure 3.7: COM port setting

- g. Enter a connection Name and change an icon. (Figure 3.8)
- h. Click the “Finish” button. (Figure 3.9)

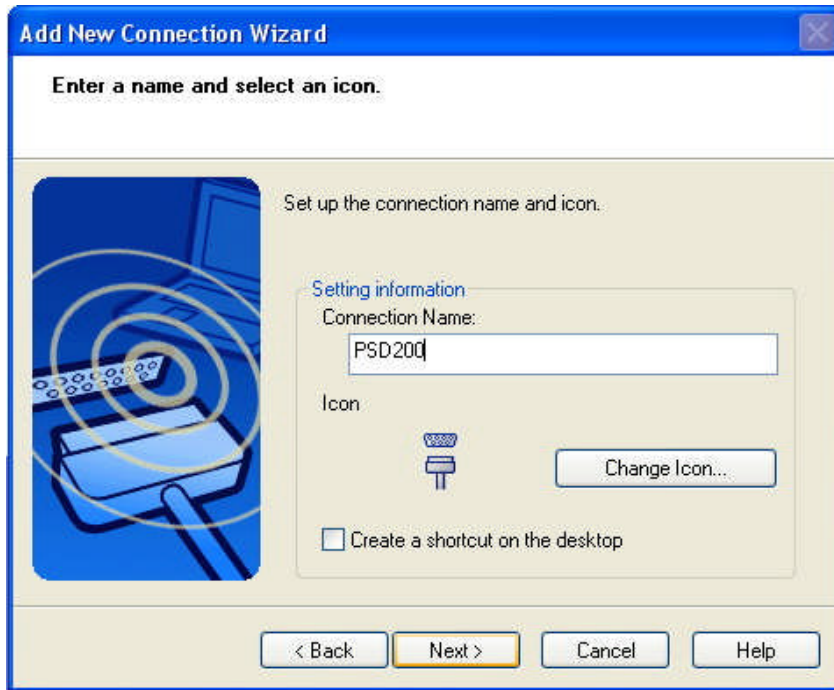

Figure 3.8: Enter a name and select an icon.

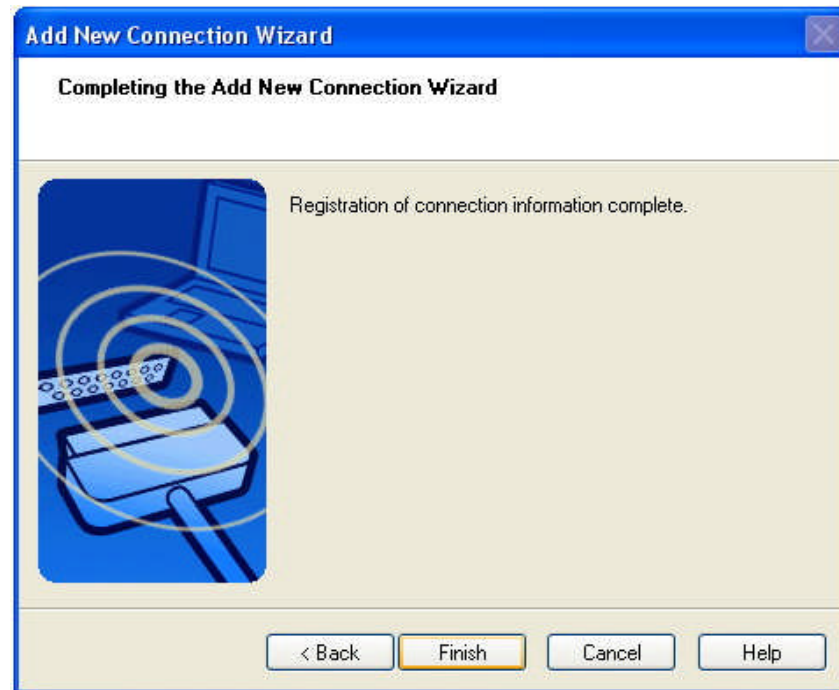

Figure 3.9: Complete the Connection Wizard

- i. Double-click the SPP connection icon just configured. (Figure 3.10)
- j. The connection is established successfully. You can use Bluetooth serial port. (Figure 3.11)
- k. To disconnect the connection, right-click on the connection icon. And then click “Disconnect”

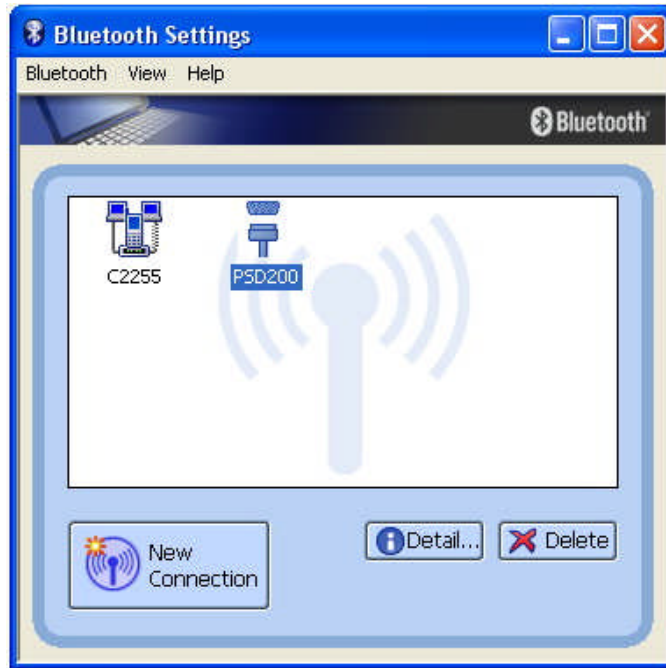

Figure 3.10: Connect SPP

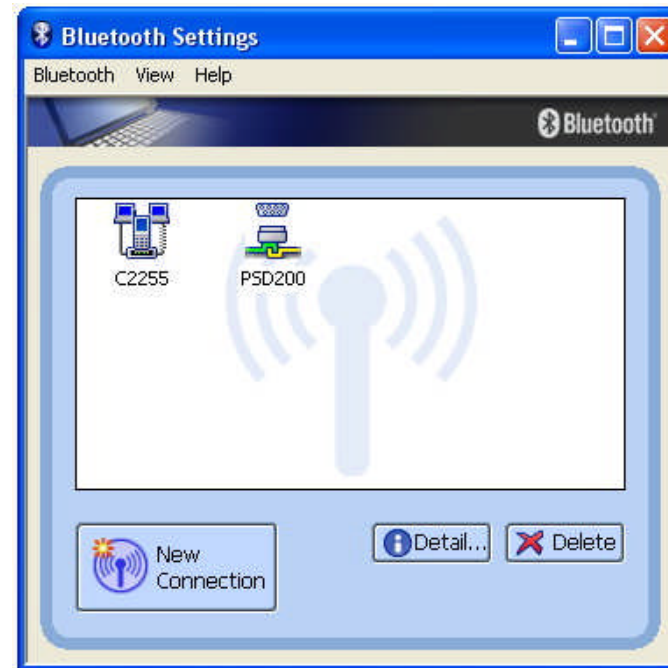

Figure 3.11: Complete the Connection

3.2. Using Dial-up Network (DUN)

This section describes how to connect to the Internet using a mobile telephone.

You must have already signed up with a provider and obtained a connection ID and password. Please ensure you have confirmed the ID, password and telephone number of your provider's access point before you begin the set-up process.

A Bluetooth passkey (PIN code) is required for to connect to. Please make a note of your Bluetooth passkey.

- a. Right-click on the Bluetooth Manager icon in the tray, and then click on "Add New Connection" (Figure 3.12)
- b. Select the "Custom Mode", and then click the "Next" button (Figure 3.13)

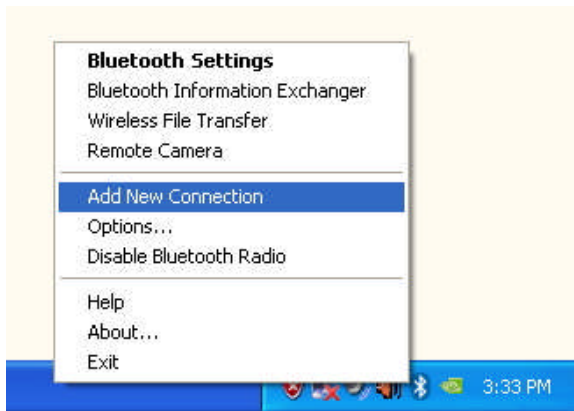

Figure 3.12: Add New Connection



Figure 3.13: Select the "Custom Mode"

- c. Select the device name of the mobile telephone, and then click the “Next” button. (Figure 3.14)
- d. Select "Dial-up Networking", and then click the “Next” button (Figure 3.15)

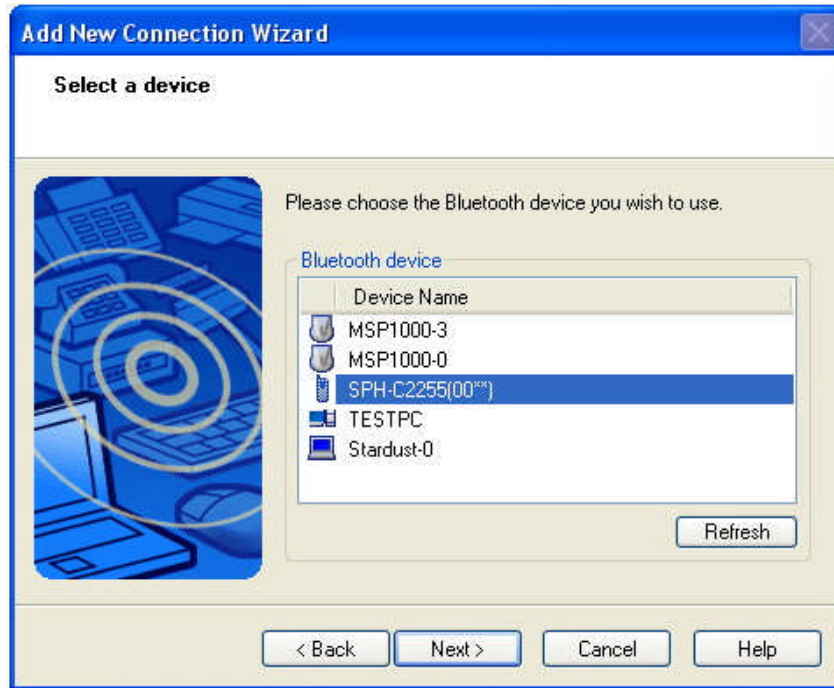

Figure 3.14: Select the Mobile Telephone

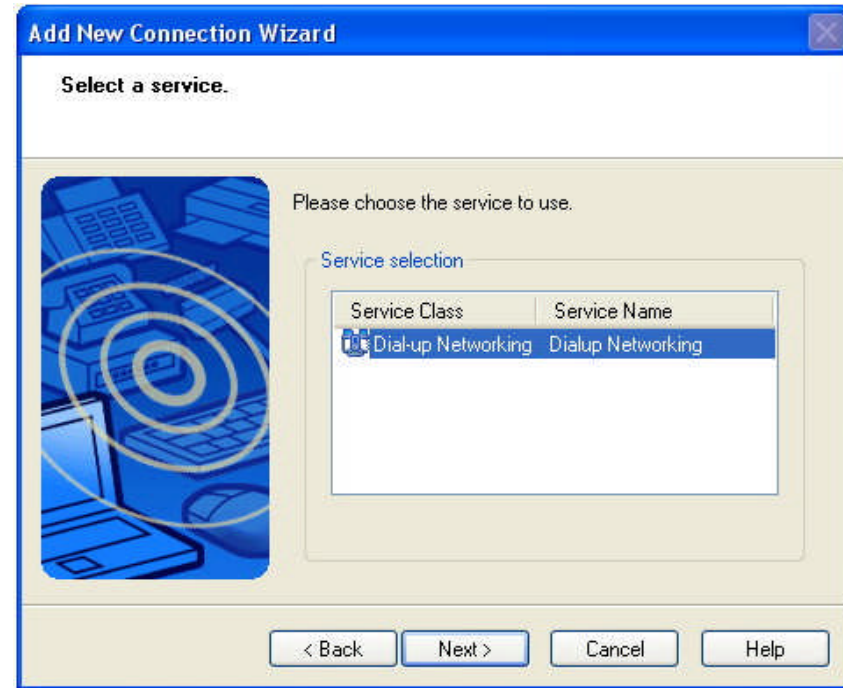

Figure 3.15: Select the “Dial-up Networking”

- e. If you are connecting to the wireless modem station for the first time, type the Bluetooth Passkey (PIN Code). And then click the “OK” button (Figure 3.16)
- f. Certain modems require you to configure initialization commands separately. Please refer to the modem or mobile phone instruction manual for further details on the initialization commands. Once the configuration is done or if it’s not needed, click the “Next” button (Figure 3.17).



Figure 3.16: Type the PIN Code

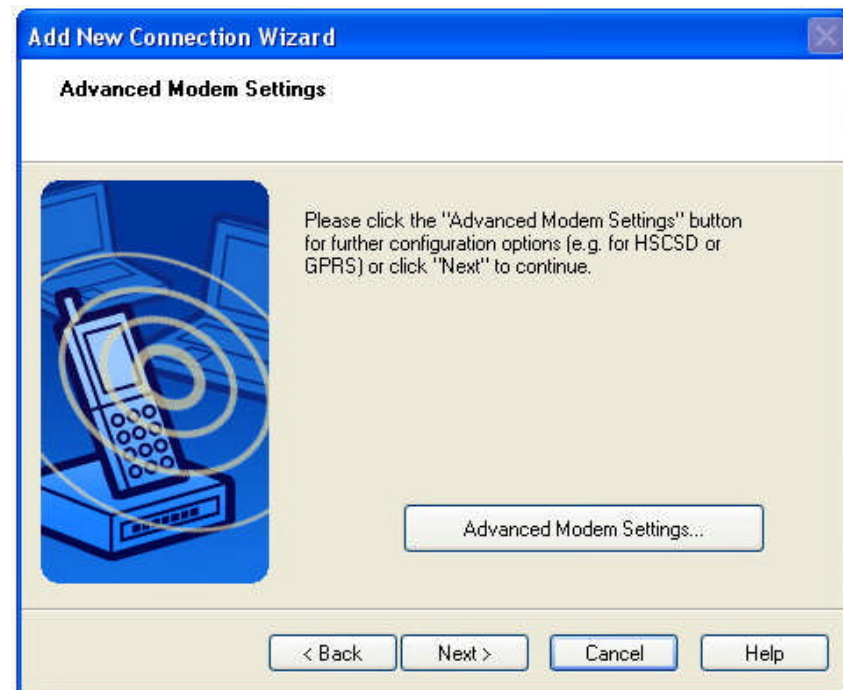

Figure 3.17: Advanced Modem Setting

- g. Type your own telephone number, ID and password according to the arrangement with your provider. And then click the “Finish” button. The settings will be registered, and the connection icon will appear in the “Bluetooth Settings” window. (Figure 3.18)
- h. Start your network application, then the “Dial-up Connection” window will appear. Click the “Connect” button. Once you have connected to the Internet, a message and a connection icon will appear in the task tray (Figure 3.19)
- i. To disconnect the connection, right-click on the connection icon. And then click “Disconnect”.



Figure 3.18: Create Dial-up Connection

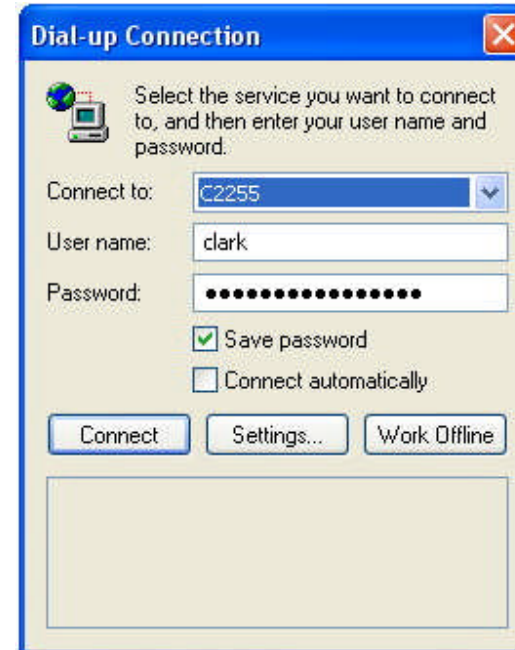

Figure 3.19: Dial-up Connection

3.3. Using Bluetooth Stereo Headset

This section describes how to use the Bluetooth stereo headset to listen to your stereo music.

A Bluetooth passkey (PIN code) is required for to connect to. Please confirm your headset PIN code.

- a. Right-click on the Bluetooth Manager icon in the tray, and then click on “Add New Connection” (Figure 3-20)
- b. Turn your headset on and activate "Discoverable" mode.
- c. Select the “Custom Mode”, and then click the “Next” button (Figure 3-21)

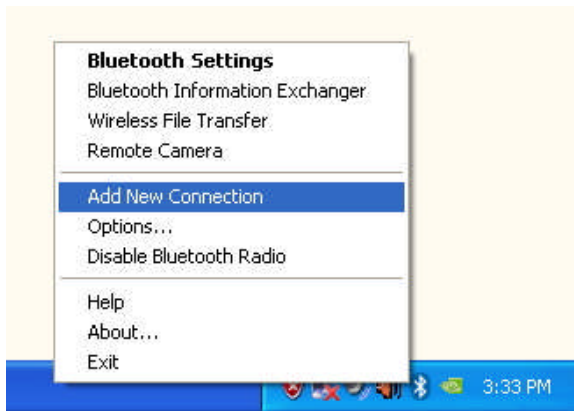

Figure 3.20: Add New Connection



Figure 3.21: Select the “Custom Mode”

- d. Select the device name of the stereo headset, and then click the “Next” button. (Figure 3.22)
- e. Select "Audio Sink", and then click the “Next” button (Figure 3.23)

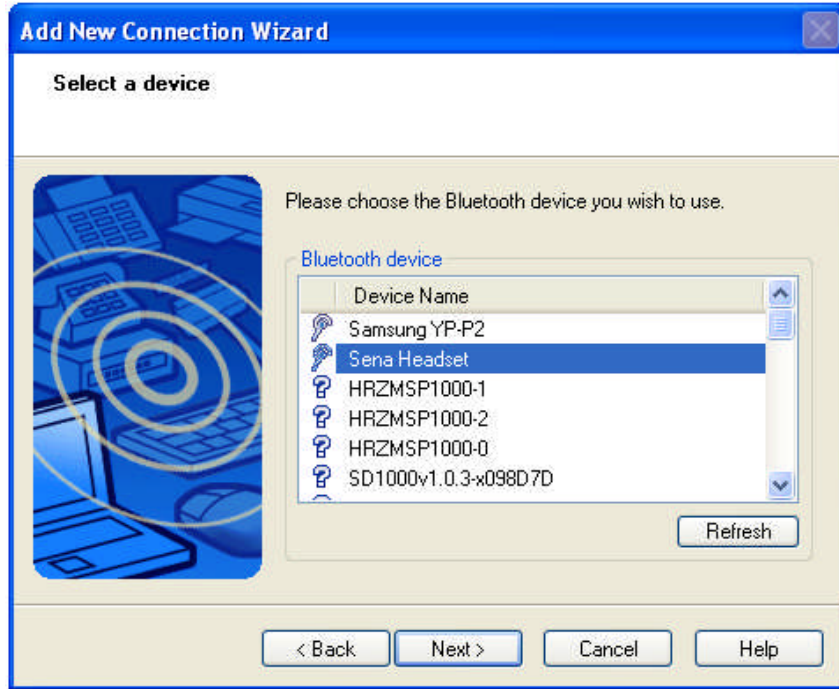

Figure 3.22: Select the Stereo Headset

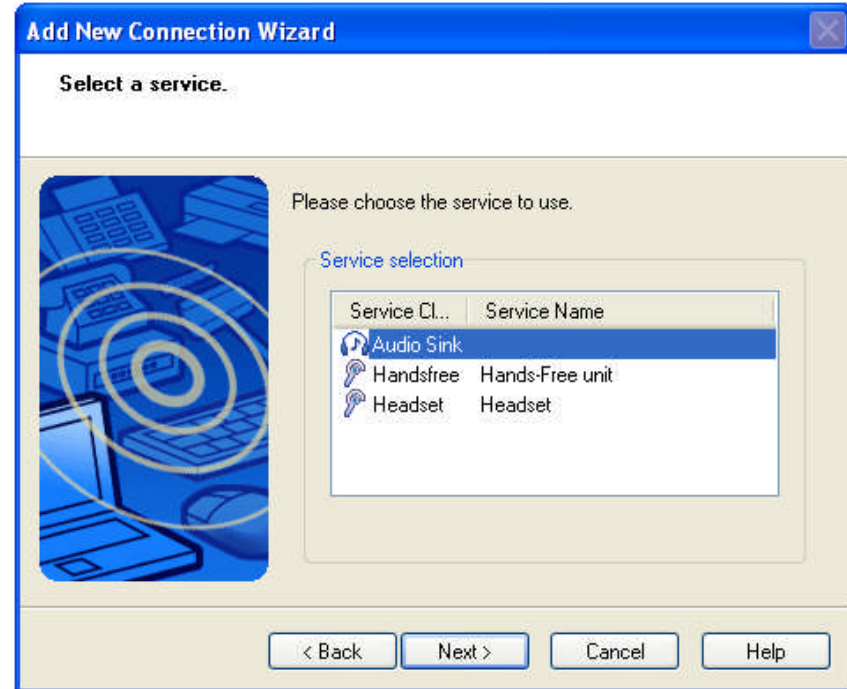

Figure 3.23: Select the “Audio Sink”

- f. If you are connecting to the stereo headset for the first time, type the Bluetooth Passkey (PIN Code). And then click the “OK” button (Figure 3.24)
- g. Enter a connection Name and change an icon. (Figure 3.25)

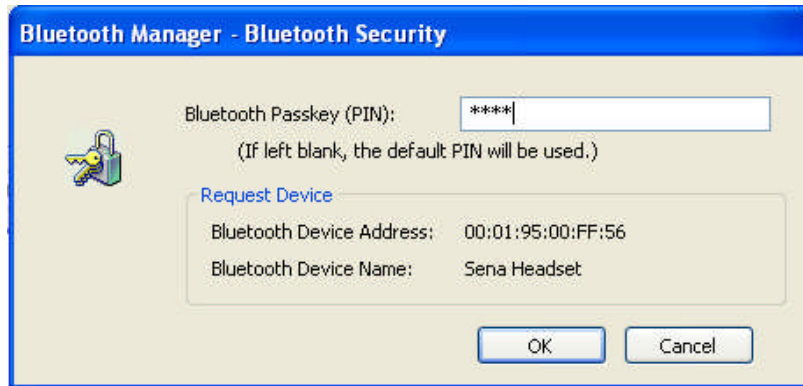

Figure 3.24: Type the PIN Code

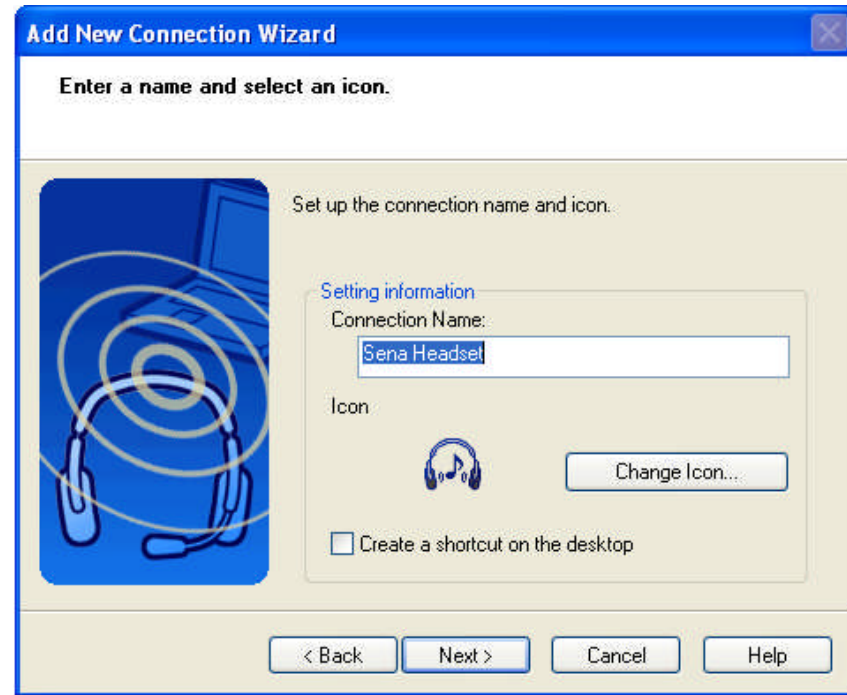

Figure 3.25: Enter a name and select an icon.

- h. Click the “Finish” button. (Figure 3.26)
- i. The connection is established successfully. You can listen to your stereo music. (Figure 3.27)
- j. To disconnect the connection, right-click on the connection icon. And then click “Disconnect”.

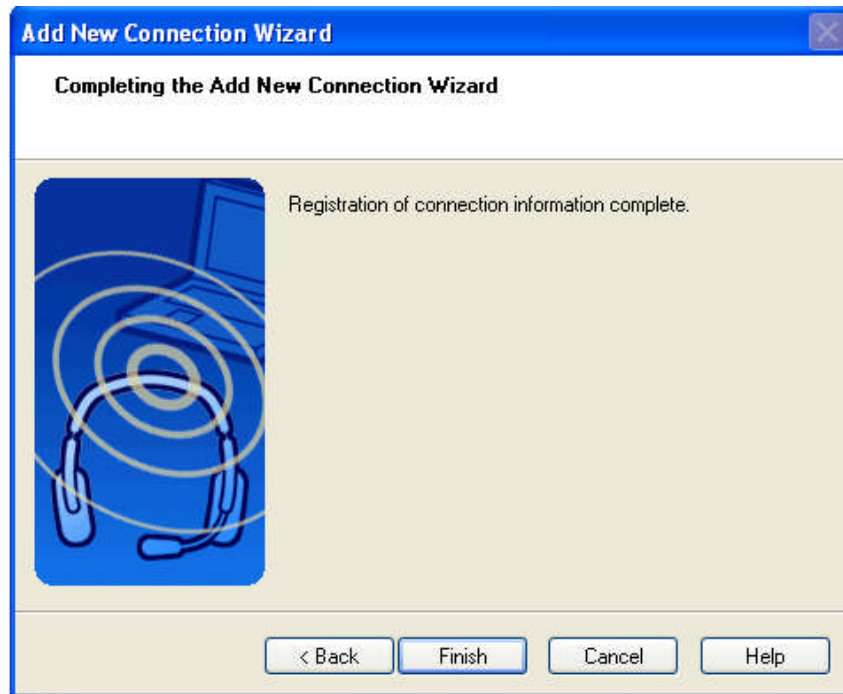
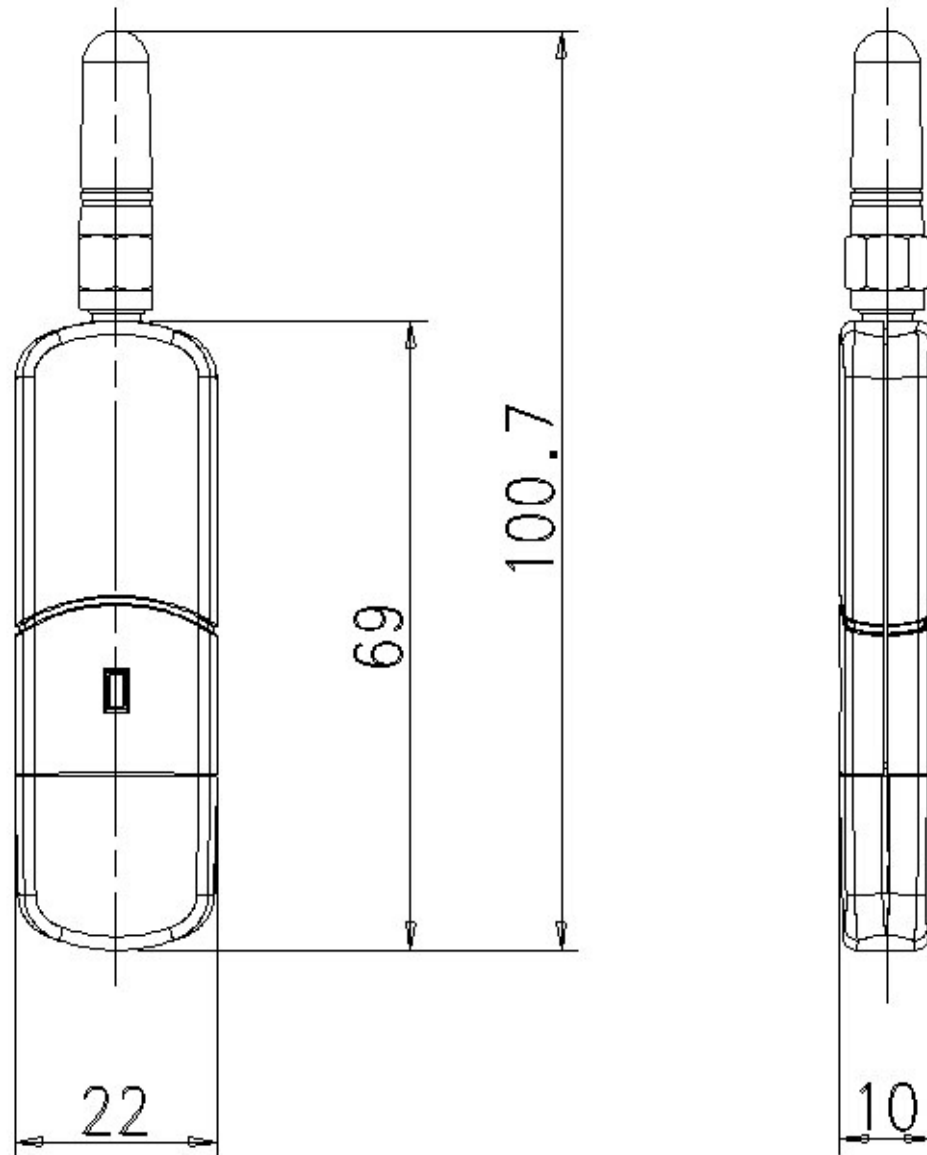

Figure 3.26: Complete the Connection Wizard



Figure 3.27: Complete the Connection

Appendix A. Mechanical Drawing



Appendix B. Warranty

B.1. GENERAL WARRANTY POLICY

Sena Technologies, Inc. (hereinafter referred to as SENA) warrants that the Product shall conform to and perform in accordance with published technical specifications and the accompanying written materials, and shall be free of defects in materials and workmanship, for the period of time herein indicated, such warranty period commencing upon receipt of the Product.

This warranty is limited to the repair and/or replacement, at SENA's discretion, of defective or non-conforming Product, and SENA shall not be responsible for the failure of the Product to perform specified functions, or any other non-conformance caused by or attributable to: (a) any misapplication or misuse of the Product; (b) failure of Customer to adhere to any of SENA's specifications or instructions; (c) neglect of, abuse of, or accident to, the Product; or (d) any associated or complementary equipment or software not furnished by SENA.

Limited warranty service may be obtained by delivering the Product to SENA or to the international distributor it was purchased through and providing proof of purchase or receipt date. Customer agrees to insure the Product or assume the risk of loss or damage in transit, to prepay shipping charges to SENA, and to use the original shipping container or equivalent.

B.2. LIMITATION OF LIABILITY

EXCEPT AS EXPRESSLY PROVIDED HEREIN, SENA MAKES NO WARRANTY OF ANY KIND, EXPRESSED OR IMPLIED, WITH RESPECT TO ANY EQUIPMENT, PARTS OR SERVICES PROVIDED PURSUANT TO THIS AGREEMENT, INCLUDING BUT NOT LIMITED TO THE IMPLIED WARRANTIES OF MERCHANTABILITY AND FITNESS FOR A PARTICULAR PURPOSE. NEITHER SENA NOR ITS DEALER SHALL BE LIABLE FOR ANY OTHER DAMAGES, INCLUDING BUT NOT LIMITED TO DIRECT, INDIRECT, INCIDENTAL, SPECIAL OR CONSEQUENTIAL DAMAGES, WHETHER IN AN ACTION IN CONTRACT OR TORT (INCLUDING NEGLIGENCE AND STRICT LIABILITY), SUCH AS, BUT NOT LIMITED TO, LOSS OF ANTICIPATED PROFITS OR BENEFITS RESULTING FROM, OR ARISING OUT OF, OR IN CONNECTION WITH THE USE OF FURNISHING OF EQUIPMENT, PARTS OR SERVICES HEREUNDER OR THE PERFORMANCE, USE OR INABILITY TO USE THE SAME, EVEN IF SENA OR ITS DEALER HAS BEEN ADVISED OF THE POSSIBILITY OF SUCH DAMAGES. IN NO EVENT WILL SENA OR ITS DEALERS TOTAL LIABILITY EXCEED THE PRICE PAID FOR THE PRODUCT.

B.3. HARDWARE PRODUCT WARRANTY DETAILS

WARRANTY PERIOD: SENA warranties embedded hardware Product for a period of one (1) year, and external hardware Product for a period of three (3) or five (5) years according to the Product type.

WARRANTY PROCEDURE: Upon return of the hardware Product SENA will, at its option, repair or replace Product at no additional charge, freight prepaid, except as set forth below. Repair parts and replacement Product will be furnished on an exchange basis and will be either reconditioned or new. All replaced Product and parts become the property of SENA. If SENA determines that the Product is not under warranty, it will, at the Customers option, repair the Product using current SENA standard rates for parts and labor, and return the Product at no charge in or out of warranty.

WARRANTY EXCLUSIONS: Damages caused by

- Accidents, falls, objects striking the SENA product,
- Operating the Product in environments that exceed SENA's temperature and humidity specifications,

- Power fluctuations, high voltage discharges,
- Improper grounding, incorrect cabling,
- Misuse, negligence by the customer or any other third party,
- Failure to install or operate the product (s) in accordance to their SENA User Manual,
- Failure caused by improper or inadequate maintenance by the customer or any other third party,
- Floods, lightning, earthquakes,
- Water spills,
- Replacement of parts due to normal wear and tear,
- Hardware has been altered in any way,
- Product that has been exposed to repair attempts by a third party without SENA's written consent,
- Hardware hosting modified SENA Software, or non-SENA Software, unless modifications have been approved by SENA.
- Battery component capacity degradation due to usage, aging, and with some chemistry, lack of maintenance.

B.4. SOFTWARE PRODUCT WARRANTY DETAILS

WARRANTY PERIOD: SENA warranties software Product for a period of one (1) year.

WARRANTY COVERAGE: SENA warranty will be limited to providing a software bug fix or a software patch, at a reasonable time after the user notifies SENA of software non-conformance.

B.5. THIRD-PARTY SOFTWARE PRODUCT WARRANTY DETAILS

The warranty policy of the third-party software is conformed to the policy of the corresponding vendor

Appendix C. Contact Information

If you have any questions regarding the product, please contact your local dealer/distributor or contact us directly as contact information below:

Contact Technical Support

Web http://www.sena.com/support/contact_support/
Email support@sena.com
Phone Toll Free (US/Canada): 1-8668-US-SENA (1-866-887-7362)
Outside from US/Canada: +1 (408) 573-7425

Contact Sales

Web http://www.sena.com/where_to_buy/contact_sales/
Email sales@sena.com
Phone Toll Free (US/Canada): 1-8668-US-SENA (1-866-887-7362)
America: +1 (408) 573-7425
EU/Africa: +33 (0) 1 53 53 16 29
Asia/Pacific: +82 (2) 529-7024